

APOLLO ATHLETICS

Since 1992



FITNESS EQUIPMENT CATALOG 2019



OUR CORE VALUES

CUSTOMER COMMITMENT- we hope to develop long standing associations that will make a positive influence in each and every customer's life.

QUALITY- we will provide outstanding Fitness equipment at value prices along with unsurpassed service that will create exceptional value to our customers.

INTEGRITY- we will uphold the highest standards in all our actions.

RESPECT- we understand that each member of our team and every customer are to be respected for their uniqueness.

ACCOUNTABILITY- we are each personally responsible for delivering on our Core Values 100% of the time with no exception!

OUR MISSION

CRAFTED with a simple goal: To provide an exceptional shopping experience with an unparalleled selection of physical fitness equipment at highly competitive prices!

Our California based team of dedicated professionals, averages more than 20 years of multi-faceted fitness experience! As a result of our extensive relationships with world renown manufacturers and suppliers, in coordination with our comprehensive backgrounds, we know we can provide the best equipment and guidance to help anyone meet their fitness goals. But more directly, we promise to treat each person with respect, and to support their fitness journey with honesty, integrity and humanity!



TABLE OF CONTENTS

ABOUT US.....	3
COMMERCIAL FITNESS EQUIPMENT	
BALANCE & MOBILITY.....	4 - 5
DUMBBELLS.....	6
KETTLEBELLS.....	7
BARBELLS.....	8 - 9
PLATES.....	10 - 11
BARS.....	12 - 15
COLLARS.....	16
WALL BALL.....	17
STRENGTH/CONDITIONING.....	18
CROSS TRAINING RIGS.....	19 - 20
RACKS & BENCHES.....	21 - 22
RESIDENTIAL FITNESS EQUIPMENT	
BALANCE & MOBILITY.....	23 - 25
DUMBBELLS.....	26 - 27
KETTLEBELLS.....	28
BARBELL SETS.....	29
BARBELLS.....	30 - 31
BARS.....	32
PLATES.....	33
COLLARS.....	34
BENCHES / RACKS.....	34 - 39
MATS.....	40 - 41
AEROBIC STEPS / BALLS.....	42
GLOVES / BELTS.....	43
CABLE ATTACHMENTS.....	44 - 46
BOXING EQUIPMENT.....	47
PLYOMETRIC BOX.....	48
HOME EXERCISE ITEMS.....	49 - 50



APOLLO ATHLETICS

APOLLO ATHLETICS, is a wholesaler of fitness equipment specializing in free weights and gym equipment/accessories, headquartered in Anaheim, California. We have been supplying retailers with excellent products and service since 1992.

Our pricing is very competitive and product is consistent in color, always in stock and with high quality. We are sensitive to our customers needs and are constantly updating our products and programs to better serve you. We have our own lift-gated trucks and drivers, which allows us to provide better service. Our driver will unload and help transfer products to your storeroom upon request.

We have warehouses in Anaheim, CA, Tacoma, WA , Elgin, IL and Atlanta, GA.

www.apolloathletics.com





Commercial Balance & Mobility



POWER RESISTANCE BANDS IR7500

- » Eco-friendly 100% natural rubber with 4mm thick and 2080 mm long
- » Resistance levels, ranging from 20 to 150 lbs.
- » EASY TO USE in any commercial or home gym.
- » IRON BULL logo in white



A SET OF 5 SIZES FOAM PLYO BOXES IR7301

- » Outside made of with durable and beautiful PVC fabric
- » Inside made of ultra dense foam for comfort and flexibility
- » Available Heights 3", 6", 12", 18", 24"
- » Weight: 2.7 kg, 4 kg, 7 kg, 10 kg, 13 kg
- » Iron Bull logo

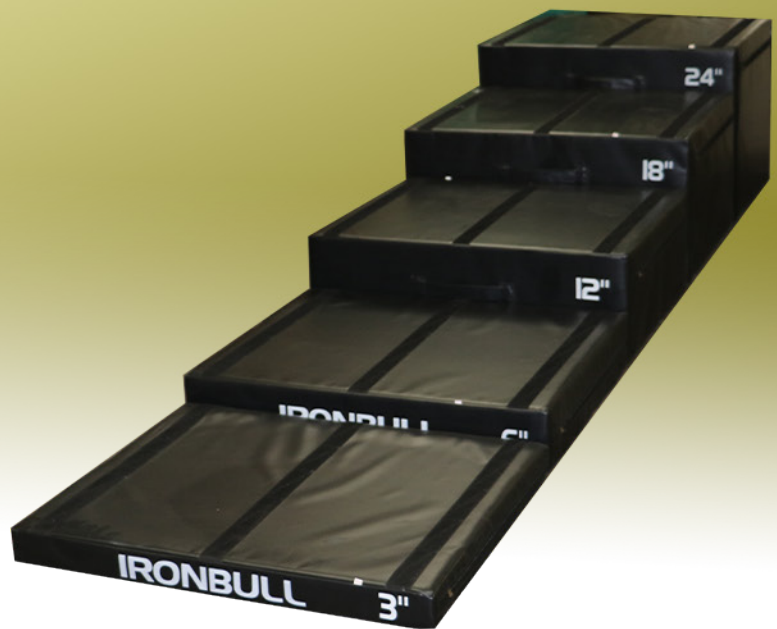

3-IN-1 COMMERCIAL USE SOFT FOAM PLYO BOX IR7211

- » Outside made of with durable and beautiful PVC fabric
- » Inside made of heavy duty ultra dense EVA foam for comfort and flexibility and wood core for increased stability
- » Can be easily adjust to three different heights: 30", 24" and 20"
- » Weight: 22 kg / 50 lbs
- » Iron Bull logo



3-IN-1 COMMERCIAL USE SOFT FOAM PLYO BOX IR7202

- » Outside made of with durable and beautiful PVC fabric
- » Inside made of heavy duty ultra dense EVA foam for comfort and flexibility and wood core for increased stability
- » Can be easily adjust to three different heights: 30", 24" and 20"
- » Weight: 8.5 kg / 18.70 lbs
- » Iron Bull logo





Commercial Dumbbells

RUBBER COATED DUMBBELL

Item Id: IR3103

- » Solid steel heads with rubber encased and perfect surface
- » Fully welded as single piece
- » Well knurled chrome handle for firm but comfortable grip
- » Available in 5 - 100 lbs (in 5 lbs increments)
- » Iron Bull logo



URETHANE DUMBBELL

Item Id: IR3300

- » Urethane is odor free and will protect floors and equipment
- » Steel handles have a hard chromed finish that will not flake or peel
- » Available in 5 - 100 lbs (in 5 lbs increments)
- » Iron Bull logo



Commercial Kettlebells

STERLING STEEL HANDLE COMPETITION KETTLEBELL Item Id: IR1200

- » Sterling steel handle ductile cast iron body competition kettlebell, handle rust resistance
- » Different color-coded for each size, easy to identify
- » Available in 8 kg, 10 kg, 12 kg, 16 kg, 20 kg, 24 kg, 28 kg, 32 kg
- » Iron Bull Logo



GRAVITY CAST IRON KETTLEBELL Item Id: KBC (in lbs)

- » Gravity cast iron kettlebells with smooth, flat bottom
- » Powder coated ensures consistent finish and feel
- » Use for squats, throws, cleans, jerks, snatches, rotational swings and more
- » Available in 5 lbs, 10 lbs, 15 lbs, 20 lbs, 25 lbs, 30 lbs, 35 lbs, 40 lbs, 45 lbs, 50 lbs



6 DIGITAL TIMER Item Id: IR7802

- » Single-Sided LED Clock Display with 6" numbers
- » Will mount to wall, wall mounting accessories included
- » Remote control for convenient pausing/re-programming
- » Count up and down options





Commercial Barbells

RUBBER FIXED STRAIGHT BARBELL

Item Id: IR4103

- » Solid steel heads with rubber encased and perfect surface
- » Fully welded as single piece
- » Chrome-plated straight bar with knurling for easy grip
- » Available in 20 - 110 lbs (in 10 lbs increment)
- » Iron Bull logo



RUBBER FIXED CURL BARBELL

Item Id: IR4104

- » Solid steel heads with rubber encased and perfect surface
- » Fully welded as single piece
- » Chrome-plated curl bar with knurling for easy grip
- » Available in 20 - 110 lbs (in 10 lbs increment)
- » Iron Bull logo





Commercial Barbells



The logo is fixed with dumbbell each other, so will avoid the problem of the fall of the logo after using

URETHANE STRAIGHT BARBELL

Item Id: IR4301



- » Urethane ends will not split, peel or chip, odor free
- » Solid steel core, fully welded as single piece
- » Chrome-plated straight bar with knurling for easy grip
- » Available in 20 - 110 lbs (in 10 lbs increment)
- » Iron Bull logo

URETHANE CURL BARBELL

Item Id: IR4302



- » Urethane ends will not split, peel or chip, odor free
- » Solid steel core, fully welded as single piece
- » Chrome-plated curl bar with knurling for easy grip
- » Available in 20 - 110 lbs (in 10 lbs increment)
- » Iron Bull logo



Commercial Plates



4-GRIPS RUBBER WEIGHT PLATE

Item Id: IR5100

- » Rubber coated, cast iron core with stainless steel insert for added durability
- » 4 grip holes for easier carrying
- » Available in 2.5 lbs, 5 lbs, 10 lbs, 25 lbs, 35 lbs, 45 lbs
- » Iron Bull logo

BLACK RUBBER BUMPER PLATE

Item Id: IR5101

- » All weights have the same diameter (450 mm)
- » Stainless steel rim bushing for added durability
- » Available in 10 lbs, 15 lbs, 25 lbs, 35 lbs, 45 lbs
- » Iron Bull logo or printed customer's logo



COLORFUL COMPETITION BUMPER PLATE

Item Id: IR5102

- » Solid steel core with industrial hard chrome center, customers logo printing available
- » Virgin rubber encased plates, 2 years warranty against defects
- » Chrome-plated curl bar with knurling for easy grip
- » Available in 25 lbs, 35 lbs, 45 lbs and 55 lbs
- » Accurate to within a 1% (+ or -) weight



COLORFUL COMPETITION BUMPER PLATE

Item Id: IR5202

- » Solid steel core with industrial hard chrome center, customers logo printing available
- » Virgin rubber encased plates, 2 years warranty against defects
- » Available in 10 kg, 15 kg, 20 kg, 25 kg
- » Accurate to within a 1% (+ or -) weight tolerance

Commercial Plates



BLACK URETHANE 3-GRIP PLATE

Item Id: IR5301

- » Durable urethane encased, no odor, free maintenance and solid
- » 3-grip design offers a comfortable grip and an easier way when using
- » Available in 2.5 lbs, 5 lbs, 10 lbs, 25 lbs, 35 lbs and 45 lbs
- » Laser cut customer logo or no logo

URETHANE ENCASED 4-GRIPS PLATE

Item Id: IR5300



- » Most durable Urethane encased, virtually indestructible and maintenance free
- » Four grip holes for easier carrying
- » Available in 2.5 lbs, 5 lbs, 10 lbs, 25 lbs, 35 lbs and 45 lbs
- » Iron Bull logo

PU ENCASED 3-GRIPS PLATE

Item Id: IR5500



- » Most durable PU encased, virtually indestructible and maintenance free
- » Three grip holes for easier carrying
- » Available in 2.5 lbs, 5 lbs, 10 lbs, 25 lbs, 35 lbs, 45 lbs
- » Iron Bull logo or laser cut customer's logo

CRUMB RUBBER BUMPER PLATE

Item Id: IR5104



- » High-TEMP Rubber Plate, no odor
- » All weights have the same diameter (450 mm)
- » Stainless steel rim bushing for added durability
- » 10 lbs can match 3000 times dropping test, others can match 20,000 times
- » Available in 10 lbs, 15 lbs, 25 lbs, 35 lbs, 45 lbs



Commercial Bars



IRON BULL MEN'S 1500 LBS BAR
Item Id: IR2201

- » High alloy steel with fully hard chrome, rust resistance and lowest maintenance
- » 4 needle bearings, ensure smooth consistent rotation of the sleeves
- » One bronze bushing in each sleeve
- » Precision knurl allows for a positive grip, dual knurl markings for weightlifting and power-lifting
- » 2200mm long, 28mm diameter grip and weighs 20 kg



IRON BULL MEN'S 1500 LBS BAR
Item Id: IR2202

- » Black zinc coated shaft and hard chrome sleeves
- » 4 needle bearings, ensure smooth consistent rotation of the sleeves
- » One bronze bushing in each sleeve
- » Precision knurl allows for a positive grip, dual knurl markings for weightlifting and power-lifting
- » 2200mm long, 28mm diameter grip and weighs 20 kg



IRONBULL MEN'S 1500 LBS BAR
Item Id: IR2203

- » Whole bar black zinc coated
- » 4 needle bearings, ensure smooth consistent rotation of the sleeves
- » One bronze bushing in each sleeve
- » Precision knurl allows for a positive grip, dual knurl markings for weightlifting and power-lifting
- » 2200mm long, 28mm diameter grip and weighs 20 kg
- » Iron bull logo

Commercial Bars



IRONBULL WOMEN'S 1000 LBS BAR

Item Id: IR2010

- » Hard chrome finish is more durable and decreases the liability associated with chipping, cracking or peeling
- » 4 Needle bearings ensure smooth, consistent rotation
- » One bronze bushing in each sleeve
- » 2010mm long, 25 mm diameter grip, and weighs 15kg
- » Iron Bull logo end caps



OB-86B-1000 LBS BLACK ZINC BAR, 28 MM

Item Id: IR2206

- » Whole bar black zinc coated
- » One bronze bushing in each sleeve
- » Precision knurl allows for a positive grip, dual knurl markings for weightlifting and power-lifting
- » 2200mm long, 28mm diameter grip and weighs 20 kg
- » Iron Bull logo



OLY 86 1000 LBS ALLOY BAR, 28MM

Item Id: IR2207

- » Alloy hard chrome finish is more durable and decreases the liability associated with chipping, cracking or peeling
- » One bronze bushing in each sleeve
- » 1000 lbs bar, 28mm weighs 20 kg
- » Iron Bull logo



Commercial Bars

WALK-IN 56" OLYMPIC BAR

Item Id: IR7600



- » Heavy duty walk-in Hex/Trap Bar
- » 56" Olympic bar
- » Dual handle with comfort knurling



Cerakote Bars



NEW PRODUCT

CERAKOTE BEARING BAR FOR WOMEN

Item Id: IR2023



- » Cerakote coated shaft last 70x longer than chromed and even stainless steel
- » Cerakote handle with hard chromed sleeves
- » Diameter: 25 mm
- » Length: 6.6' (79.13")
- » Middle part length: 51.5"
- » 4 needles bearings ensures smooth and consistent rotation
- » 6 stage of knurling
- » Iron Bull logo on end of sleeves

Cerakote Bars



NEW PRODUCT

CERAKOTE BEARING BAR FOR MEN Item Id: IR2224

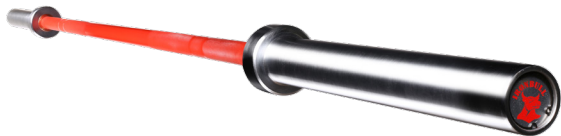

- » Cerakote coated shaft last 70x longer than chromed and even stainless steel
- » Cerakote handle with hard chromed sleeves
- » Diameter: 28 mm
- » Length: 86.6"
- » Middle part length: 51.5"
- » 4 needles bearings ensures smooth and consistent rotation
- » 6 stage of knurling
- » Iron Bull logo on end of sleeves

CERAKOTE BEARING BAR FOR MEN Item Id: IR2225



NEW PRODUCT

- » Cerakote coated shaft last 70x longer than chromed and even stainless steel
- » Cerakote handle with hard chromed sleeves
- » Diameter: 28 mm
- » Length: 86.6"
- » Middle part length: 51.5"
- » 4 needles bearings ensures smooth and consistent rotation
- » 6 stage of knurling
- » Iron Bull logo on end of sleeves



Commercial Collars



LOCK JAW COLLAR

Item Id: IR7800

- » For any bar with dia 2" sleeves
- » Quick release, superior durability
- » Color options: black, red and blue



LOCK JAW COLLAR

Item Id: IR7801

- » For any bar with dia 2" sleeves
- » Quick release, superior durability
- » Color options: blue, yellow, red and aluminum color

Commercial Wall Balls



Wall Ball Item Id: IR7101

- » Made of durable synthetic leather and designed for superior grip
- » Available in 6 lbs, 8 lbs, 10 lbs, 12 lbs, 14 lbs, 16 lbs, 18 lbs, 20 lbs
- » From 8 lbs and above, with urethane inner tank to keep weight balance when using
- » Colorful Iron Bull logo embroidered

» Unique inner urethane core keeps ball's true shape throughout workout





Commercial Strength & Conditioning



POWDER SAND BAG

Item Id: IR7204

- » Made of heavy-duty PVC vinyl
- » Four handles with rubber grips are available for a variety of choices when using
- » Different colors at the both ends is easy to identify the various sizes
- » Available sizes: 5 kg, 10 kg, 15 kg, 20 kg and 25 kg



BULGARIAN POWER BAG

Item Id: IR7203

- » Made of PVC, filled with boxing cotton and sand
- » Available sizes: 8 kg, 12 kg, 15 kg, 17 kg & 22 kg
- » Iron Bull logo



Commercial Cross Training Racks



GHD EXERCISE ROMAN CHAIR

Item Id: IR7105

- » Steel construction Roman Chair
- » Targets back, glutes, hamstrings and abdominal muscles
- » Durable powder coated finish
- » Dimensions: 2380 x 790 x 1080 mm



Cross Training-RIG PARTS FLYING PULL-UP ATTACHMENT

Item Id: IR75306-18

- » Durable powder coated finish
- » Available diameter and width of the Round tube: 32mm * 3mm/1.25" * 0.12"
- » Available length: 1800mm / 70"



Cross Training-RIG PART UPRIGHT STAND

Item Id: IR75301-27S

- » Durable coated finish
- » Available height: 2700 mm / 9'
- » Available type of upright stand: Four sides with holes and Laser engraving number on two sides



Cross Training-RIG PARTS MULTIFUNCTIONAL BEAM

Item Id: IR75302-18

- » Durable powder coated finish
- » Available diameter and width of the Round tube: 32mm * 3mm/1.25" * 0.12"
- » Available length: 1800 mm / 70"



Cross Training-RIG PARTS MULTIFUNCTIONAL BEAM

Item Id: IR75304-18

- » Durable powder coated finish
- » Available diameter and width of the Round tube: 32mm * 3mm/1.25" * 0.12"
- » Available length: 1800 mm / 70"

Commercial Cross Training Racks



Cross Training-RIG PARTS SAFETY SPOTTING ARMS Item Id: IR75308-00



- » Durable powder coated finish with special plastic for protecting bars
- » Available length: 600mm/23.6"

Cross Training-RIG PARTS MONSTER DIP BAR Item Id: IR75310-00



- » Durable powder coated finish
- » Available dimension: L 160 * W 360 * H 200 mm/6.3" * 14.17" * 7.87"

Cross Training-RIG PARTS WALL BALL TARGET Item Id: IR75311-00



- » Durable powder coated finish
- » Available dimension: H 450 mm/17.7"

Cross Training-RIG PARTS MONKEY BAR Item Id: IR75317-11



- » Durable powder coated finish
- » Available diameter 32 mm/1.25" and length: 1100 mm/ 43"

Cross Training-RIG PARTS MONKEY BAR Item Id: IR75317-18



- » Durable powder coated finish
- » Available diameter 32 mm/1.25" and length: 1800 mm/ 70"

Cross Training-RIG PARTS BOXING BAG RACK Item Id: IR75319



- » Durable powder coated finish
- » Available dimension: L 800 * H 355 mm/31.50" * 13.98"



Commercial Racks

IRON BULL DUMBBELL RACK

Item Id: IR6300

- » Durable powder coated finish, great surface
- » Two tier design with flat oval steel tube, load is up to 1000 kg
- » Perfect weld construction
- » Easy to assemble



BARBELL RACK

Item Id: IR6400

- » Durable powder coated finish and great surface
- » Perfect design with flat oval steel
- » Easy to assemble
- » Perfect weld construction
- » 10 positions for barbell storage



BARBELL RACK

Item Id: IR6200



- » Bar rack holds 10 bars
- » Heavy duty, 12 mm thick, steel frame
- » Powder coated finish
- » Product size: 900 x 600 x 300 mm
- » Packing size: 950 x 620 x 210 mm

CABLE CROSSOVER

Item Id: IR1016

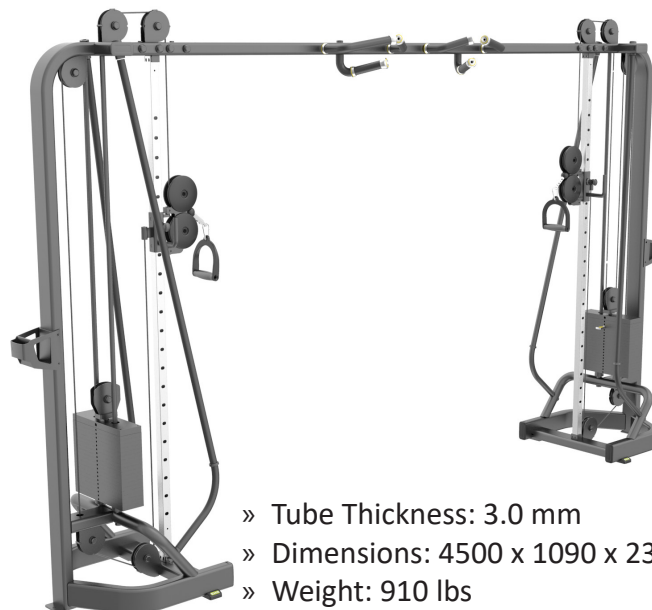

- » Tube Thickness: 3.0 mm
- » Dimensions: 4500 x 1090 x 2310 mm
- » Weight: 910 lbs

Commercial Benches & Racks

FLAT BENCH

Item Id: IR1036



- » Tube Thickness: 3.0 mm
- » Dimensions: 1410 x 680 x 420 mm
- » Weight: 65 lbs

ADJUSTABLE DECLINE BENCH

Item Id: IR1037



- » Tube Thickness: 3.0 mm
- » Dimensions: 1640 x 680 x 990 mm
- » Weight: 125 lbs

MULTI-PURPOSE BENCH

Item Id: IR1038



- » Tube Thickness: 3.0 mm
- » Dimensions: 1060 x 680 x 900 mm
- » Weight: 65 lbs

SUPER BENCH

Item Id: IR1039

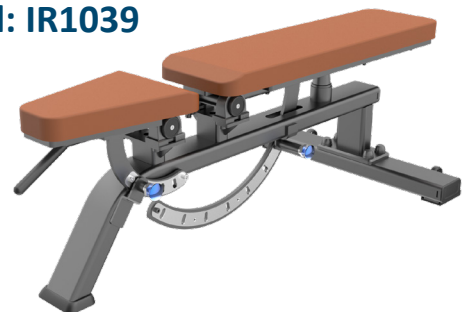

- » Tube Thickness: 3.0 mm
- » Dimensions: 1060 x 680 x 690 mm
- » Weight: 93 lbs

FUNCTIONAL TRAINER

Item Id: IR1017



- » Tube Thickness: 3.0 mm
- » Dimensions: 1050 x 1760 x 2250 mm
- » Weight: 770 lbs

Balance & Mobility



AEROBIC BARS A-BAR

- » 48" long x 1.25" handle
- » Solid steel construction
- » Foam covering allows for easy grip during exercises
- » Weights available: 4 lbs, 6 lbs, 9 lbs, 12 lbs & 15 lbs



GLUTE HAM G-HAM

- » High density foam with easy to clean 18 oz vinyl cover
- » Great exercise for the entire posterior chain
- » Critical piece of strength training equipment
- » 16" W x 10" H curved upper pad

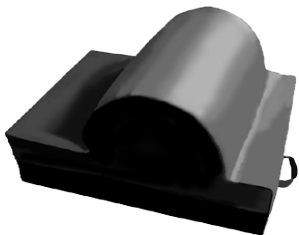

INDIAN CLUB EXERCISE BAT E-BAT

- » Cast iron with smooth black finish
- » Machined handle for consistent and safe grip
- » Symmetrically balanced for optimum weight equalization
- » Available sizes: 5 lbs, 10 lbs, 15 lbs, 20 lbs



MACE BELL M-BELL

- » All steel construction
- » Commercial heavy-duty quality for use in all types of facilities
- » Evenly weighted and completely spherical head (no flat top)
- » Available sizes: 10 lbs, 15 lbs, 20 lbs, 25 lbs, 30 lbs, 35 lbs, 40 lbs





Balance & Mobility



FITNESS HAMMER

Item Id: F-HAM

- » Durable steel construction
- » Machined knurled over 90% of handle for easy stress free grip
- » Head is welded to handle for increased safety and performance
- » Symmetrically balanced for optimum weight equalization
- » Available sizes: 10 lbs, 15 lbs, 20 lbs, 25 lbs, 30, lbs

EXERCISE STRENGTH RUBBER BANDS

Item Id: ESB



- » Heavy duty latex rubber loops (40" long and 3/16" thick)
- » 6 color coded widths/resistance levels



ESB-Handle

5 PC SET RESISTANCE BAND

Item Id: EST-5 SET



- » 3 resistance levels: Light, Medium and Heavy
- » Soft grip handles
- » Double layer of latex designed to ensure the elastic force remains true over continuous usage

AGILITY LADDER

Item Id: LADDER-S



- » Fixed rungs save set-up time and withstand abuse from cleats and surface conditions
- » Easy carry bag with handle

20 NEOPRENE DUMBBELL SET W/ TREE

Item Id: NEO-20 SET



- » Easy grip neoprene coating
- » Rubber-like coating helps protect floors
- » Weights can be used for both indoor / outdoor use
- » Weight stand (tree) included
- » Size: 2 lbs, 3 lbs and 5 lbs





Balance & Mobility



VINYL BLACK JUMP ROPE, 10'
Item Id: JR-B

- » Vinyl cable jump rope w/ PVC handles



LEATHER JUMP ROPE, 10'
Item Id: JR-L

- » Leather cable with soft foam handles



SPEED JUMP ROPE W/ METAL-DOWEL
Item Id: JR-SPEED

- » Light-weight w/ effortless grip

FOAM ROLLER
Item Id: FR-24



- » Lightweight, medium-density foam
- » Diameter 6" / Length 36"
- » Weight: 1.2 lbs

FOAM ROLLER (HARD)
Item Id: FR-36-H

- » Lightweight High-density molded Epp polypropylene foam
- » Diameter 6" / Length 36"
- » Weight: 1 lb



AB MAT
Item Id: AB-MAT



- » Dimensions: 15" L x 12" W x 3" H
- » Weight: 2 lbs

BALANCE PAD
Item Id: BLP

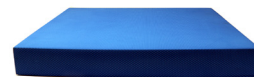

- » EVA closed cell foam
- » Dimensions: 19" L x 15" W x 2" H
- » Weight: 1.16 lbs

BALANCE CUSHION
Item Id: BLC

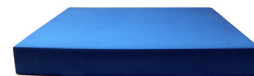

- » Moisture-resistance shell
- » Dimensions: 13" round
- » Weight: 2 lbs

Dumbbells



Grey Cast Iron Hex Dumbbell Item Id: HD

- » Cast iron construction
- » Durable resin-based paint and baked finish
- » Abrasion and corrosion resistant
- » Available sizes: 1 lbs - 120 lbs

RUBBER HEX DUMBBELL Item Id: HDRS



- » Chrome contoured knurled handles
- » Durable rubber-covered heads for increased safety and comfort
- » Head threaded and permanently attached to solid steel shaft
- » Available sizes: 3 lbs - 100lbs
- » Available sets: 5 lbs - 50 lbs set & 55 lbs - 100 lbs set





Dumbbells

VINYL DUMBBELL VCD-B

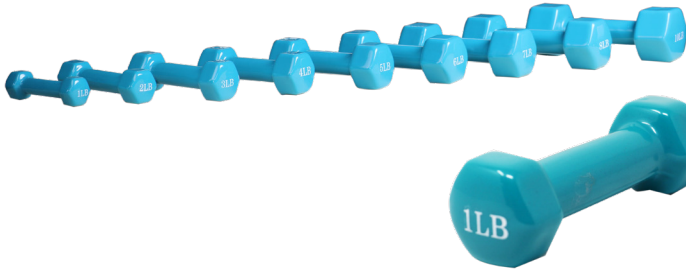

- » Vinyl Coated Hand Weights
- » All-Purpose Color Coded
- » Durable with easy weight identification
- » Available sizes: 1 lbs, 2 lbs, 3 lbs, 4 lbs, 5 lbs, 6 lbs, 7 lbs, 8 lbs, 10 lbs

NEOPRENE DUMBBELL NEO-N



- » Cast iron construction
- » Blue neoprene coating
- » Abrasion and corrosion resistant
- » Available sizes: 1 lbs, 2 lbs, 3 lbs, 4 lbs, 5 lbs, 6 lbs, 7 lbs, 8 lbs, 9 lbs, 10 lbs, 12 lbs, 15 lbs, 20 lbs

DUMBBELL HANDLES SDH



- » Solid steel 1 1/6" shaft
- » Chrome knurled handles
- » Abrasion and corrosion resistant

FIXED DUMBBELL FD



- » Build your own dumbbells
- » Fixed dumbbells 5 lbs to 160 lbs





Kettlebells

GRAVITY CAST IRON KETTLEBELL

Item Id: KB-LB

- » Gravity cast iron kettlebells with smooth, flat bottom
- » Powder coated to make sure perfect surface
- » Use for squats, throws, cleans, jerks, snatches, rotational swings and more
- » Available in 5 lbs, 10 lbs, 15 lbs, 20 lbs, 25 lbs, 30 lbs, 35 lbs, 40 lbs 45 lbs, 50 lbs



KETTLEBELL

Item Id: KB-KG



- » Cast iron construction
- » Durable resin-based paint and baked finish
- » Abrasion and corrosion resistant
- » Available sizes: 4 kg, 8 kg, 12 kg, 16 kg, 20 kg, 24 kg, 28 kg, 32 kg, 36 kg, 40 kg, 44 kg, 48 kg

BLUE NEOPRENE KETTLEBELL

Item Id: KBN



- » Cast iron construction
- » Neoprene coating
- » Abrasion and corrosion resistant
- » Available sizes: 5 lbs, 10 lbs, 15 lbs, 20 lbs, 25 lbs, 30 lbs

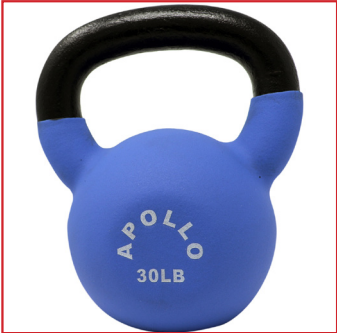

Barbell Set



1" GRAY 110 lbs SET
Item Id: GR-110 SET

- » Steel construction
- » Chrome coated knurling
- » 110 lbs set with 85 lbs plates
- » 60" spinlock bar
- » 2 Dumbbell handles

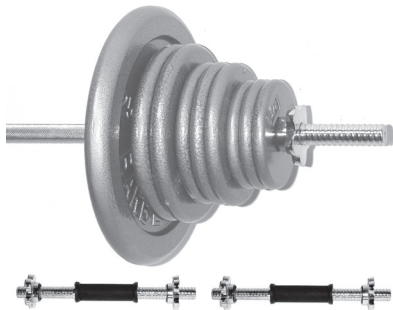

1" GRAY 160 lbs SET
Item Id: GR-160 SET

- » Steel construction
- » Chrome coated knurling
- » 160 lbs set with 135 lbs plates
- » 72" spinlock bar
- » 2 Dumbbell handles



300 lbs OLYMPIC SET
Item Id: OBH-86-300

- » 7" Olympic Chrome Bar
- » 2 spring clip collars
- » Plates: 2 x 2.5 lbs, 4 x 5 lbs, 2 x 10 lbs, 2 x 25 lbs, 2 x 35 lbs, 2 x 45 lbs



2" OLYMPIC BASE SET
Item Id: GOD-84 SET,
GOD-86 SET

- » 2" Gray Olympic base set
- » 84" or 86" bar
- » Plates: 2 x 2.5#, 4 x 5#, 2 x 10#
- » 2 x collars



2" OLYMPIC BASE SET
Item Id: GOG-84 SET,
GOG-86 SET

- » 2" Dark Gray Olympic base set
- » 84" or 86" bar
- » Grip plates: 2 x 2.5#, 4 x 5#, 2 x 10#
- » 2 x collars



DUMBBELL HANDLE

Item Id: RHD-14

- » Steel construction
- » Chrome coated
- » Rubber handle & spinlock



CHROME CURL BAR

Item Id: SCB-47

- » Steel construction
- » Chrome coated
- » 47" Curl bar w/ star collar



SUPER CHROME CURL BAR

Item Id: SSCB-47

- » Steel construction
- » Chrome coated
- » 47" Chromed super curl bar

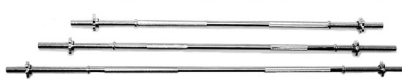

SPINLOCK BARS

Item Id: SSB-60, 72, 84

- » Steel construction
- » Chrome coated with star collars
- » Available bar sizes: 60", 72" & 84"



34" SOLID TRICEP BAR

Item Id: SST-34

- » Steel construction
- » Chrome coated with star collars



34" SOLID SMOOTH TRICEP BAR

Item Id: ST-34

- » Steel construction
- » Smooth bar with star collars

Barbells



47" SMOOTH CURL BAR

Item Id: CB-47

- » Steel construction
- » Chrome coated
- » 47" smooth bar with collars

OLYMPIC CURL BAR

Item Id: OC-47



- » 47" Olympic curl bar



47" SUPER SMOOTH CURL BAR

Item Id: CB-47 SUPER

- » Steel construction
- » Chrome coated
- » 47" Super smooth bar with collars

OLYMPIC SUPER CURL BAR

Item Id: OC-47S



- » 47" Super curl bar

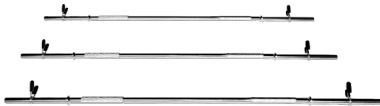

CHROME SMOOTH BAR

Item Id: SB-60, 72, 84

- » Steel construction
- » Chrome coated smooth bar with collars
- » Available bar sizes: 60", 72" & 84"

47" BLACK CURL BAR

Item Id: OBH-47



- » Steel construction
- » 4' (high-end) no collar

OLYMPIC DUMBBELL HANDLE

Item Id: ODH-20



- » 20" dumbbell handle with collars



47" OLYMPIC BAR

Item Id: OCH-47

- » Steel construction
- » Chrome coated
- » 47" (high-grade) with brass bushing

OLYMPIC TRICEP BAR

Item Id: OT-34



- » Steel construction
- » Chrome coated knurling
- » 34" tricep bar with collars



OLYMPIC BARS

Item Id: OB-60, OB-72, OB-84, OB-86"



- » Steel construction
- » Chrome coated
- » Available sizes: 60", 72", 84" & 86"

OB-86B-1000 lbs BAR

Item Id: IR2206



- » Whole bar black zinc coated
- » One bronze bushing in each sleeve
- » Precision knurl allows for a positive grip, dual knurl markings for weightlifting and power-lifting

OLYMPIC ALLOY 1000 lbs BAR

Item Id: IR2207



- » Alloy hard chrome finish is more durable and decreases the liability associated with chipping, cracking or peeling
- » One bronze bushing in each sleeve
- » 28 mm

ALUMINUM OLYMPIC LIGHT 150 lbs BAR

Item Id: OB-72ALU



- » Aluminum construction
- » 6' Ultra light (high-grade)
- » Diameter 28 mm

64" OLYMPIC HEX BAR

Item Id: OB-64HEX



- » Steel construction
- » 64" with 2 collars



1" GRAY PLATES

Item Id: GR

- » Cast iron construction
- » 1" Plates
- » Available sizes: 1.25 lbs, 2.5 lbs, 5 lbs, 7.5 lbs, 10 lbs, 12.5 lbs, 20 lbs, 25 lbs, 50 lbs



GRAY OLYMPIC DEEP PLATES

Item Id: GOD

- » Cast iron construction
- » Available sizes: 2.5 lbs, 5 lbs, 10 lbs, 25 lbs, 35 lbs, 45 lbs



DARK GRAY OLYMPIC GRIP PLATES

Item Id: GOG

- » Cast iron construction
- » Available sizes: 2.5 lbs, 5 lbs, 10 lbs, 25 lbs, 35 lbs, 45 lbs



RUBBER OLYMPIC BUMPER PLATES

Item Id: ROBS

- » Rubber coated 2" plate
- » Available sizes: 2.5 lbs, 5 lbs, 10 lbs, 25 lbs, 35 lbs, 45 lbs





Collars

1" SPRING COLLAR

Item Id: SC-1



2" SPRING COLLAR

Item Id: SC-2



1" SPINLOCK COLLAR

Item Id: SLC-1



2" OLYMPIC TRAINING COLLAR

Item Id: TC-2



ALUMINUM OLYMPIC COLLAR W/ LOCK JAW

Item Id: IR7801



BENCHES & RACKS

MEDICINE BALL RACK

Item Id: M-BALL-RACK-S



- » Can hold 5 pieces medicine balls
- » Black powder coated high strength steel tubing
- » Dimensions: 16" D x 24" W x 66" H
- » Weights: 22 lbs

DOUBLE-COLUMN MEDICINE BALL RACK

Item Id: M-BALL-RACK-D



- » Can hold 10 pieces medicine balls
- » Black powder coated high strength steel tubing
- » Dimensions: 16" D x 24" W x 66" H
- » Weights: 28 lbs

APOLLO INCLINE/FLAT/DECLINE BENCH

Item Id: RSB-400-A



- » 2" x 2" steel tubular frame construction
- » Scratch resistant black powder coat finish
- » Comfortable 1.75" upholstered pads
- » Dimensions: 45" L x 18" W (on seat) x 12" W (on back pad) 18" H (seat starting position)
- » Weight 40 lbs



BENCHES & RACKS

APOB-ARM



APOLLO OLYMPIC BENCH Item Id: APOB-A

- » 48" width durable
- » 2" x 2" steel frame
- » High Density padding
- » Black Powder Coating to resist scratches
- » User weight capacity: 275 lbs
- » Assemble Dimensions: 60" W x 52" H x 47" D



APOLLO POWER TOWER Item Id: PW-T-A

- » Commercial grade black powder coat prevents scratches
- » Heavy guage 2.4" x 2.4" 1.5 mm tubular steel
- » Dimensions: 25" W x 36" D x 82" H
- » Weight: 88 lbs



APOLLO FLAT BENCH Item Id: APFB-A

- » 2" X 2.8" Frame
- » 11.5" thick wide
- » 2" thick padding
- » Stabilizing rubber foot pads
- » Matte black powder coat finish resists scratches
- » User weight capacity: 275 lbs
- » Assembled Dimensions: 46" L x 23" W x 18 1/4" H





BENCHES & RACKS



INTEGRAL SQUAT RACK

Item Id: RSB-314

- » 42" Wide
- » Adjustable 35" - 65" Squat Stand/Bench Press Rack
- » Max load should not exceed 275 lbs
- » 5" back plate to catch bar
- » 2.5" mouth opening for bar support
- » Weight: 35.2 lbs



SQUAT RACK WITH ADJUSTABLE WIDTH

Item Id: RSB-308

- » High tensile strength steel
- » Black powder coating to resist scratches
- » Rubber end caps providing protection and stability
- » Adjust from 38" - 68" height with back plate to catch bar
- » 2.5" mouth opening for bar support and safety
- » Max load should not exceed 250 lbs
- » Weight: 41.8 lbs



PULL UP SYSTEM

Item Id: PULL-UP-RACK

- » Durable solid steel construction
- » Black powder-coated finish protects
- » Heavy-duty assembly bolts flush to support brackets
- » Hold's up to 400 lbs
- » Dimensions: 44" W x 36" D x 23" H
- » Weight: 38 lbs



BENCHES & RACKS



A-FRAME DUMBBELL RACK

Item Id: DBR-A

- » A-Frame, space saving design
- » White powder coated finish
- » Rubber feet to provide stability
- » Stores up to 6 dumbbells
- » Dimensions: Overall height 33" H x 20" W
- » Weight: 31 lbs

2-Tier Dumbbell Rack

Item Id: DBR-2



- » Heavy-gauge steel
- » White powder coated finish
- » 2 tiers that hold 10 pairs
- » Rubber shelves prevent chips and dings
- » Dimensions: 21" D x 43" L x 32" H
- » Weight: 54 lbs

3-Tier Dumbbell Rack

Item Id: DBR-3M



- » Heavy grade 2" x 2" steel tubing frame welded construction has durable scratch resistant
- » White powder coated finish
- » Accommodate multiple size dumbbells
- » Dimensions: 43" L x 36" H x 24" D
- » Weight: 86 lbs

3-TIER DUMBBELL RACK

Item Id: DBR-3S



- » Heavy grade 2" x 2" gauge steel tubing frame with welded construction has durable scratch resistant
- » White powder coated finish
- » 3 black powder coated open shelves
- » Dimensions: 24" W x 35" H
- » Weight: 42 lbs



BENCHES & RACKS

3-TIER RACK FOR RUBBER HEX-DUMBBELLS

Item Id: DBR-3R



- » Heavy duty construction combined with satin black finish
- » Black powder coated finish
- » Store up to 13 pairs of rubber hex dumbbells
- » Dimensions: 57" x L x 37" H x 11" D
- » Weight 88 lbs

SQUAT RACK WITH ADJUSTABLE WIDTH

Item Id: KB-R



- » Heavy gauge steel rack
- » Frame welded on all four sides
- » Grey/black powder coated
- » Dimensions: 58" W x 26" H
- » Weight: 96 lbs

MULTI-EXERCISE RACK

Item Id: M-RACK



- » Steel tube construction
- » Rubber grips / stabilizer feet for secure grip
- » Yellow powder coated frame resists scratches
- » Dimensions: 23" L x 16" W x 29" H
- » Weight: 25 lbs

9 PIECE BAR HOLDER

Item Id: DR-5



- » Wide base stability
- » Black powder coating resists scratches
- » Store up to 9 Olympic bars of any length
- » Dimensions: 20" L x 20" W x 8"H
- » Weight: 35 lbs



STANDARD PLATE TREE

Item Id: SPT

- » Durable 2" x 2" high tensile strength steel frame with welded construction
- » Stores up to 500 lbs of weight plates (stacks 1" or 2" plates)
- » Total of 7 pegs on the frame
- » Dimensions: 28" L x 14" W x 35" H
- » Weight: 23 lbs



OLYMPIC PLATE TREE

Item Id: OPT

- » Black powder coat chip resistant finish
- » Durable 2" x 2" high tensile strength steel frame with welded construction
- » Stores up to 500 lbs of weight plates (stacks 2" plates)
- » Total of 7 pegs on the frame
- » Dimensions: 28" L x 14" W x 35" H
- » Weight: 24 lbs



HORIZONTAL OLYMPIC PLATE RACK

Item Id: SRPT

- » Durable solid steel construction
- » Black powder-coated finish protects
- » Includes 8" of 4" width slots to hold multiple size bumper weight plates
- » Hold's up to 350 lbs
- » Dimensions: 51" L x 11.8" W x 11.8" H (total 52" L includes wheel)
- » Weight: 37 lbs



SLED

Item Id: S-RACK

- » Heavy gauge black powder coated steel
- » 500 lbs capacity
- » Includes harness hooks for external harness push / pull
- » Dimensions: 49" L x 26" W x 40" H
- » Weights 98 lbs



Mats



RUBBER MAT
Item Id: MAT-R

- » Printing on surface
- » 6' L x 4 W' x 1/2" thickness

YOGA MAT
Item Id: MAT-Y-A



- » Amazon logo
- » 2' L x 6' W x 1/4" Thickness



YOGA MAT
Item Id: MAT-Y

- » 2' x 5' x 1/6" thickness

DOUBLE LAYER YOGA MAT
Item Id: MAT-T



- » 6' L x 2' W x 1/3" Thickness

BLACK MAT
Item Id: MAT-B



- » 68" L x 24" W

Mats



HIGH-DENSITY FOAM MAT Item Id: MAT-F-1

- » Class 80 Foldable
- » 6' L x 2' W x 1" H



HIGH-DENSITY FOAM MAT Item Id: MAT-3-8-1

- » Class 80 Foldable
- » 3' L x 8' W x 1" H



HIGH-DENSITY FOAM MAT Item Id: MAT-F-H

- » Class 70 Foldable
- » 4 set per carton
- » 6' L x 2' W x 1" H

PVC MAT

Item Id: MAT-48, 60, 72, 78



- » For bike & treadmill
- » 3' x 4', 3' x 5', 3' x 6', 3 x 6.5'



PUZZLE MAT Item Id: MAT-6

- » 6 pieces per set
- » 4 set per carton
- » 2' L x 2' W x 1/2" H





Steppers & Balls

AEROBIC STEP Item Id: AS-L



- » 3 height levels (includes 4 risers)
- » Hard plastic adjustable height step
- » Dimensions: 29" L x 15" W x 9" H
- » Weight: 11 lbs
- » User capacity: 275 lbs

AEROBIC STEP Item Id: AS-XL



- » 3 height levels (includes 4 risers)
- » Hard plastic adjustable height step
- » Dimensions: 43" L x 17" W x 9" H
- » Weight: 21 lbs
- » User capacity: 300 lbs

AEROBIC STEP RISERS Item Id: AS-L-R AS-XL-R



- » Dimensions: 14" W x 10" L x 3" H
- » Weight: 1 lb
- » User weight capacity: 275 lbs



SLAM BALL Item Id: S-BALL

- » Sand filled for true no bounce
- » Balanced in heavy-duty rubber shell
- » Easy to grasp & throw with a pliable, tactified surface
- » Available sizes: 6 lbs, 10 lbs, 15 lbs, 20 lbs, 25 lbs, 30 lbs, 35 lbs, 40 lbs, 45 lbs, 50 lbs

LACROSSE BALL Item Id: L-BALL



- » Lightweight and eminently portable
- » Firm rubber measures 2 1/2" diameter
- » Sold in pairs
- » Each ball weights 8 oz.



EXERCISE BALL Item Id: E-BALL

- » High quality anti-burst stability ball
- » Dense rubber walls
- » Durable material designed to conform to the body
- » Available sizes: 55 cm, 65 cm, 75 cm
- » Capacity weight limit: 300 lbs

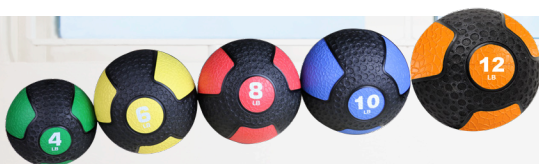

MEDICINE BALL Item Id: M-BALL

- » Basketball groove feel
- » Easy to grip hard rubber outer shell
- » Endurance in keeping shape after multiple usage
- » Available sizes: 4 lbs, 6 lbs, 8 lbs, 10 lbs, 12 lbs

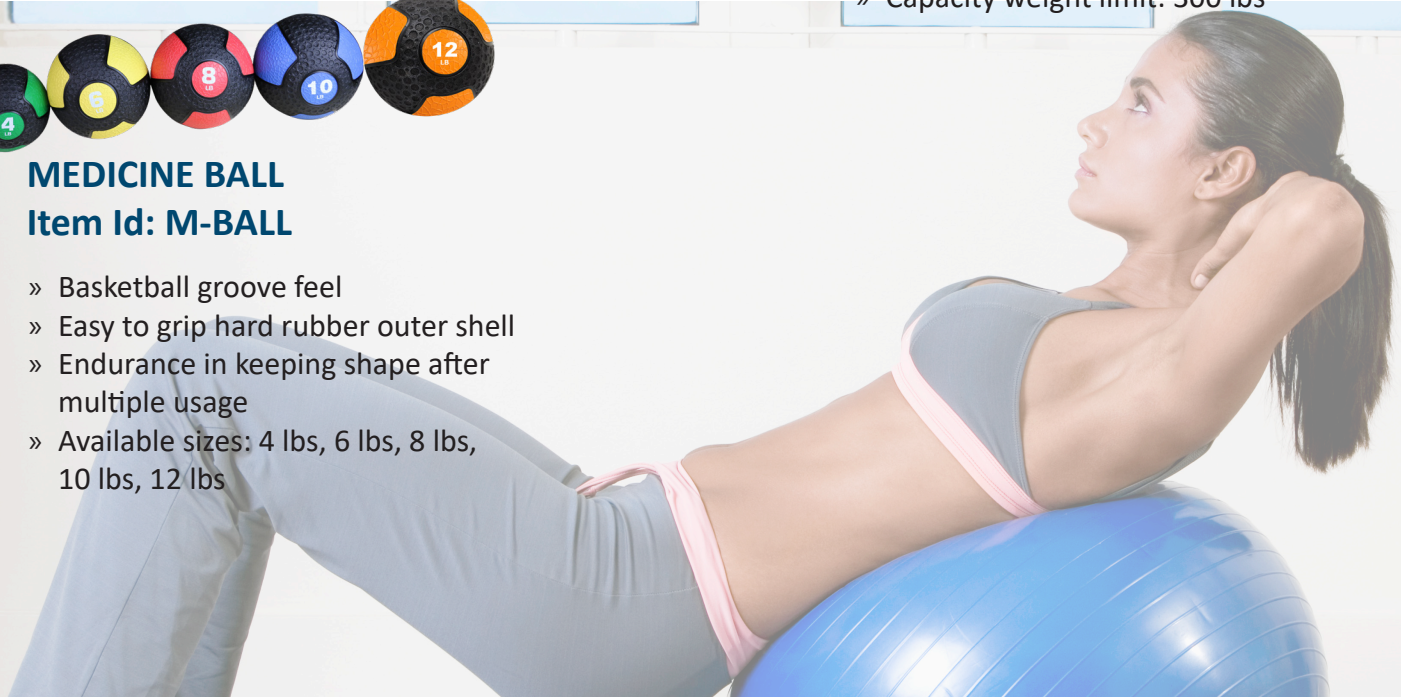



Gloves & Belts



WEIGHT GLOVES
Item Id: GV-L



LARGE WEIGHT GLOVES
Item Id: GV-XL, GV-XXL



LEATHER HEAD BELT W/ CHAIN
Item Id: H-BELT



LARGE & EX-LARGE WEIGHT BELT
Item Id: WB-L, WB-XL, WB-XXL

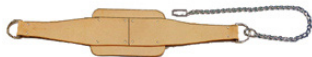

LEATHER DIPPING BELT W/ CHAIN
Item Id: D-BELT



ALUMINUM ALLOY BASE WEIGHT RAIS
Item Id: AAB

Cable Attachments

CABLE ROPE (HIGH-GRADE)Item
Id: CR-H



SINGLE GRIP CABLE HANDLE
Item Id: CH-5



SINGLE GRIP (HIGH-GRADE)
Item Id: CHH-5



DUEL PRESS BAR (HIGH-GRADE)
Item Id: DDP-7



**20" CHROMED CABLE STRAIGHT W/
RUBBER HANDLE (HIGH-GRADE)**
Item Id: RCBR-20R



DOUBLE GRIP HANDLE
Item Id: DDH-1

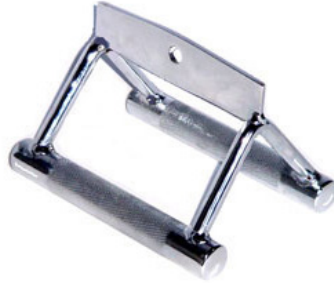

DOUBLE GRIP HANDLE (HIGH-GRADE)
Item Id: DDHH-1



36" & 48" CHROMED LAT BAR
Item Id: LB-36 48



**MULTI PURPOSE W/ RUBBER HANDLE
(HIGH-GRADE)**
Item Id: VB-25R





Cable Attachments

48" LAT BAR W/ RUBBER ENDS
Item Id: LBR-48



MULTI EXERCISE BAR W/ RUBBER ENDS
Item Id: MXB-12



24" PRO STYLE CURL BAR
Item Id: NLB-24



34" PRO STYLE CURL BAR
Item Id: NLB-34



28" CHROMED CABLE CURL BAR
Item Id: RCB-28



20" CHROMED STRAIGHT BAR
Item Id: RSB-20



28" CHROMED CABLE CURL BAR W/ RUBBER ENDS
Item Id: RCBR-28



20" CHROMED STRAIGHT BAR W/ RUBBER ENDS
Item Id: RSBR-20



NYLON SINGLE GRIP CABLE HANDLE (BLUE)
Item Id: SH-5 (BLUE)



SINGLE-GRIP RUBBER HANDLE (HIGH-GRADE)
Item Id: CHH-5R



Cable Attachments

TRICEP PRESS DOWN BAR

Item Id: TB-10



**DOUBLE GRIP RUBBER HANDLE
(HIGH-GRADE)**

Item Id: DDHH-1R



**48" LAT BAR W/RUBBER HANDLES
(HIGH-GRADE)**

Item Id: LBR-48R



**34" CHROMED W/ RUBBER HANDLE (HIGH-
GRADE)**

Item Id: NLB-34R



**MULTI EXERCISE BAR W/
RUBBER HANDLE (HIGH-GRADE)**

Item Id: MXBR-12R



**TRICEP DOWN BAR W/ RUBBER
HANDLE (HIGH-GRADE)**

Item Id: TBH-10R



**28" TRICEP BAR W/ RUBBER HANDLE
(HIGH-GRADE)**

Item Id: RCBR-28R





Boxing Equipment



BOXING HEAVY BAG
Item Id: HVBG

» Available sizes: 40, 50, 80, 100 lbs
(with strap)



BOXING HEAVY BAG CEILING KIT
Item Id: HVBG-K



HEAVY BAG/SPEED BAG STAND
Item Id: HVBG-R

» 91" H x 51" W x 52" D

Plyometrical Box

IRON PLYO-METRICAL BOX

Item Id: PB

- » Heavy duty 1" steel construction with fully welded frames and solid ribbed top to prevent skid
- » Wid base and angled construction prevents tipping
- » Stackable for easy space saving storage
- » Powder coated chip resistant finish
- » Available sizes: Height 12", 18", 24", 30", 36"



WOOD PLYO-METRICAL BOX

Item Id: PB-WOOD

- » 3-in-1 design to exact specs for Cross Training Games Competition
- » 3/4" ultra smooth beveled plywood for durability
- » Capacity: 400 lbs recommended max weight
- » Dimensions: 20" x 24" x 30"
- » Weight: 51 lbs





BLUE TRAMPOLINE
Item Id: TMP-4



» Diameter 40"

ANKLE WEIGHTS
Item Id: AW



» Available sizes: 2 lbs, 5 lbs, 10 lbs

ADJUSTABLE CHROMED DOOR BAR
Item Id: D-BAR



» Available sizes: 6" 9" 12" 18" H

ADJUSTABLE ANKLE WEIGHTS
Item Id: AWA



» Available sizes: 5 lbs, 10 lbs

STRENGTH RUBBER BANDS
Item Id: ESB



» Available sizes: 6" 9" 12" 18" H

Home Exercise Items

EXERCISE WHEEL

Item Id: EW



» Double wheel

10 MM CHROMED METAL HOOK

Item Id: HK-10



8 MM CHROMED METAL HOOK

Item Id: HK-8



WEIGHTED VEST

Item Id: H-VEST



» Available sizes: 22 lbs & 44 lbs

HAND GRIP, HARD

Item Id: HG-H



HAND GRIP, SOFT

Item Id: HG-S



BAR PAD

Item Id: PAD-14



» 14" Density Neoprene Bar Pad



TRADE IN / TRADE UP PROGRAM

Trade in your old equipment for new high quality Ironbull commercial equipment at discount prices.

- ▶ When you buy Ironbull equipment, we'll buy your old equipment, regardless of the condition.
- ▶ We'll give you \$0.30 per pound for your equipment.
- ▶ Program exclusive to only: Dumbbells, Kettlebells, Bars, and Plates. (Must be cast iron, steel or rubber)
- ▶ FREE pickup and delivery. (must be with Southern California)

Great way to keep your equipment fresh and new.

Trade In / Trade Up!

Visit

**<http://ironbullfitness.us/trade-in>
for more information.**



Headquarters & Main Warehouse

1428 W. Central Park Ave. S, #C
Anaheim, CA 92802
Toll Free: (800) 264-7763
Office: (714) 533-8118
Fax: (714) 533-8218
info@apolloathletics.com

Other Warehouses

902 Center Street
Tacoma, WA 98409

2300 Glavin Dr
Egin, IL 60124

4200 Steve Reynolds Blvd, Ste 6
Atlanta, GA 30093



www.apolloathletics.com